



# High-Resolution CCD Camera Model CS3910BH

## Specifications

### Contents

1.PRODUCT DESCRIPTION	6
2.FEATURES	6
3.COMPONENTS	6
4.FUNCTION	7
5.SPECIFICATIONS	12
6.TIMING CHART	15
7.EXTERNAL-VIEW DRAWINGS	18

**TOSHIBA TELI CORPORATION**



# Important Safety Precautions

## **BEFORE USE - GENERAL SAFETY INSTRUCTIONS**

This specifications contains important information for the operator (user) and/or people in the vicinity to avoid personal injury, or property damage.

- Prior to use, read this specifications carefully to fully understand its instructions for correct use.
- After reading, keep operation manual near the equipment for future reference.



## **WARNINGS & CAUTIONS**

Indication	Meaning
 <b>WARNING</b>	This indicates the existence of a hazard that death or catastrophic bodily injury(*1) may result from improper use.
 <b>CAUTION</b>	This indicates the existence of a hazard that bodily injury(*2) or property damage(*3) may result from improper use.

Notes

- \*1 Catastrophic bodily injury means loss of eyesight, burns (high and low temperature), shock, fracture, poisoning, etc. which leaves a sequela and require hospitalization or prolonged treatment.
- \*2 Bodily injury means injuries, burns and electric shock which does not require hospitalization or prolonged treatment.
- \*3 Property damage means extended harm to home, household effects, domesticated animals, and pets.

## **Graphic symbol definitions**

Indication	Meaning
	This mark indicates a prohibited action that must not be carried out. The actual prohibited action is indicated in the symbol or nearby graphically or described in text.
	This mark indicates a mandatory action that must not be carried out. The actual instruction is indicated in the symbol or nearby graphically or described in text.

## ● Handling Precautions

### **WARNING**

#### **Stop operation immediately when any abnormality or defect occurs.**



Use during an abnormal condition; such as emitting smoke, burning odors, damage from dropping invasion of foreign objects, etc. may cause fire and/or electric shock. Be always sure to disconnect the power plug from the electrical outlet (socket) at once and contact your dealer.



#### **Do not operate in places with possibility of becoming wet.**

This may cause fire and/or electric shock.



**Do not repair, disassemble and/or modify by yourself.**

This may cause fire and/or electric shock. Be always sure to contact your dealer for internal repair, check and cleaning of the product.



**Don't place things or materials on the unit.**

Ingress of foreign materials such as metallic things and liquid into the unit may cause a fire or an electric shock.



**Do not put the product in an unstable, slanting and/or vibrated place.**

Drop and/or fail of the product may cause injury.



**Do not touch the power cord or other connection cables during a thunderstorm.**

This might cause electric shock.



**Use the specified power supply.**

Use of an unspecified power supply may result in fire or electric shock.



**Do not be handled roughly, damaged, fabricated, bent forcefully, pulled, twisted, bundled, placed under heavy objects or heated the power cord , connection cable.**

Otherwise, fire or electric shock may result.



**CAUTION**

**Note the following instructions when installing.**

-Do not wrap the product in an inflammable material, such as cloth.

-Do not put the product in a narrow space, since the heat generated from the product may be difficult to emanate.

If you do not follow the above, the heat generated by the product may cause fire.



**Avoid setting in humid, smoky, vaporized or dusty places. A fire or an electric shock may occur in such places.**

This may cause fire and/or electric shock.



**Do not put the product in direct sunshine and/or high temperature.**

The temperature inside the product may cause fire.



**Use the specified DC power cable or connection cable.**

Otherwise, a fire or an electric shock may occur.



**Turn OFF the power in the case of connection.**

Turn OFF the power in the case of connection of power cable or connection cable.

Otherwise, an electric shock or a malfunction may occur.



**Do not expose its camera head to any intensive light (such as direct sunlight).**

Otherwise, its inner image pickup device might get damaged.



**Avoid short-circuiting signal output.**

Otherwise, a malfunction may occur.

---



**Avoid giving a strong shock against the camera body.**

It might cause a breakdown or damage.

If your camera is used in a system where its camera connector is subjected to strong repetitive shocks, its camera connector is possible to break down. If you intend to use your camera in such a situation, if possible, bundle and fix a camera cable in the place near the camera, and do not transmit a shock to the camera connector.

---



**Ask your dealer to perform a periodical check and internal cleaning (approx. once every five years).**

Dust inside the product may cause fire and/or trouble. For check and cleaning cost, please consult your dealer.

---

---

## **DISCLAIMER (LIMITED WARRANTY)**

---

We disclaim any responsibility and shall be held harmless for any damages or losses incurred by the user in any of the following cases;

- Fire, earthquake or any other act of God; acts by third parties; misuse by the user, whether intentional or accidental; use under extreme operating conditions.
- Malfunction or non-function resulting in indirect, additional or consequential damages, including but not limited to loss of expected income and suspension of business activities.
- Incorrent use not in compliance with instructions in this instruction specifications and manual.
- Malfunctions resulting from misconnection to other equipment.
- Repairs or modifications made by the user or caused to be made by the user and carried out by an unauthorized third party.
- Notwithstanding the foregoing, Teli's liabilities shall not, in any circumstances, exceed the purchase price of the product.
- About the item which does not have a publication in the specifications and manual of this product, it considers as the outside for a guarantee.

---

## **RESTRICTION FOR USE**

---

- Should the equipment be used in the following conditions or environments, give consideration to safety measures and inform us of such usage:
  1. Use of the equipment in the conditions or environment contrary to those specified, or use outdoors.
  2. Use of the equipment in applications expected to cause potential hazard to people or property, which require special safety measures to be adopted.
- This product can be used under diverse operating conditions. Determination of applicability of equipment or devices concerned shall be determined after analysis or testing as necessary by the designer of such equipment or devices, or personnel related to the specifications. Such designer or personnel shall assure the performance and safety of the equipment or devices.
- This product is not designed or manufactured to be used for control of equipment directly concerned with human life (\*1) or equipment relating to maintenance of public services/functions involving factors of safety (\*2). Therefore, the product shall not be used for such applications.
  - (\*1): Equipment directly concerned with human life refers to.
    - Medical equipment such as life-support systems, equipment for prerating theaters.
    - Exhaust control equipment for exhaust gases such as toxic fumes or smoke.
    - Equipment mandatory to be installed by various laws and regulations such as the Fire Act or Building Standard Law
    - Equipment related to the above.
  - (\*2): Equipment relating to maintenance of public services/functions involving factors of safety refers to.
    - Traffic control systems for air transportations, railways, roads, or marine transportation
    - Equipment for nuclear power generation
    - Equipment related to the above

---

## CAUTIONS ON USE

---

- Carefully handle the units.  
Do not drop, or give a strong shock or vibration to the camera. This may cause problems. Treat the camera cables carefully to prevent cable problems, such as cable breakdown and loosened connections.
- Operating ambient temperature and humidity.  
Do not use the camera in places where temperature and humidity exceed the specifications. Picture quality will lower and internal parts may be damaged.  
Be particularly careful when using in places exposed to direct sunlight. When shooting in hot places, depending on the conditions of the object and the camera (for example when the gain is increased), noise in the form of vertical strips or white dots may occur. This is not a malfunction.
- Restriction for the lens combination  
This camera might form a ghost to image area depending on the combination of a lens and an illumination with this camera. But this is not a failure of this camera. Therefore, please check the combination of the lens and the illumination with this camera when use.  
When mounting a lens, take extra caution so that the lens is not tilted, nor does flaw exist at the lens-mount-screw part. Also check to confirm that no dirt nor other foreign object is put inside  
Improper mounting might cause the parts to become locked.
- Do not shoot under intense light.  
Avoid intense light such as spot light on part of the screen because it may cause blooming or smears. If intense light falls on the screen, vertical stripes may appear on the screen, but this is not a malfunction.
- Do not expose the camera's image-pickup-plane to sunlight or other intense light directly.  
Its inner CCD (charge-coupled device) might be damaged.
- Moire  
When thin stripe patterns are shot, stripe patterns that are not actually there (moire) may appears as interference stripes. This is not a malfunction.
- Undesirable noise  
If the camera or the cables are located near something which emit strong magnetism or near something which emit strong electric wave, undesirable noise may appear on the screen. In such a case, try to change the location of the camera or the cable wiring.
- Handling of the protection cap  
When the camera is not in use, put a lens-cap onto the camera head for protection of the image-pickup-plane.
- When not using the camera for a longtime.  
Stop supplying power for safety.
- When cleaning the camera  
Always turn off the power and clean with a piece of soft dry cloth.  
To remove stubborn stains, use a soft cloth soaked in diluted acid-free detergent. Do not use alcohol, benzine, thinner, etc. If used, coating and printed letters may be discolored.  
In case the image-pickup-plane should be settled with fine dust, dirt, or scratched, ask your dealer for technical advice.
- Wastes of this product should be separated and discarded in compliance with the various national and local ordinances.

# 1. PRODUCT DESCRIPTION

Model CS3910BH is an integrated-(one-body)-type monochrome CCD camera with a 2/3-type all-pixel-data-read-out CCD featuring high resolution.

## 2. FEATURES

- (1) High resolution  
CS3910BH features an high picture resolution through the adoption of a MEGA-pixel CCD (Total pixel number: 1,500,000 Active pixel number: 1,450,000 [1,392(H)×1,040(V)]).
- (2) Square-grid Pattern CCD  
Pixels in this CCD are aligned in a square grid pattern. This makes it easier to perform computation correctly for image processing use.
- (3) Full-frame Shutter  
As data in all pixels are read out even under RTS mode, images with no deterioration in vertical resolution are obtained.
- (4) Random Trigger Shutter (RTS)  
Random trigger shutter, which starts light-exposure in synchronization with external trigger signal, is built in. This function enables the camera to capture images at any given timing. Shutter speed is selectable among 8 scales, from 1/30s through 1/10000s.
- (5) Digital Output  
Digital format output (EIA-644 single channel 10 bit) is available.
- (6) External-sync Operation  
Upon receiving external HD/VD IN, the camera automatically switches into ex-sync operation.
- (7) All pixel read out mode (Normal mode)  
This model can readout all pixel data (effective area) in 1/15 second.
- (8) High speed draft mode  
The High-speed scanning (1/60 frame/second) is available by using high-speed reading-out method to read out 2 lines in 8 lines. Output is 267 lines.
- (9) Partial-scan Mode  
This model can readout pixel data in partial-scan format. (Screen center 1/2)
- (10) AGC  
With AGC (Automatic Gain Control) function, the camera can obtain the optimal image even if the amount of incoming light (approx.4 times) fluctuates.
- (11) Multiple Shutter  
This model can capture images at any given timing cued by ex-trigger signal input, then outputs accumulated video images at a set timing.

## 3. COMPONENTS

(1)Camera body	.....	1
(2)Accessories		
Operation manual	.....	1
(3)Option		
DC IN Cable	.....	Model CPRC3700
Digital cable	.....	Digital video cable
Tripod fixing metal		

## 4. FUNCTION

The settings of each mode can set with rear-panel and inner DIP-switches.

Rear-panel DIP-switches			Function		
Mode	SW1-2	SW1-3			
Shutter OFF	OFF	OFF	AGC (SW1-1)	Partial-scan (SW1-5)	Draft (※ 2)
Nomal Shutter ※1	ON				
·Random Trigger Shtter ·Multiple-shutter pulse mode	OFF	ON	OFF	OFF	OFF
·Random Trigger Shtter ·Multiple-shutter FIX mode ※1	ON		ON	ON	ON

\*1: The shutter-speed selectable with inner DIP switches 2 through 4.

\*2: ON / OFF selectable with inner DIP SW 1.

OFF ←→ ON

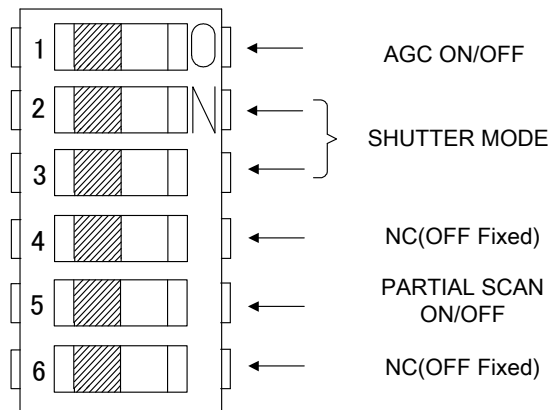

SW1 Rear-panel DIP-SW

OFF ←→ ON

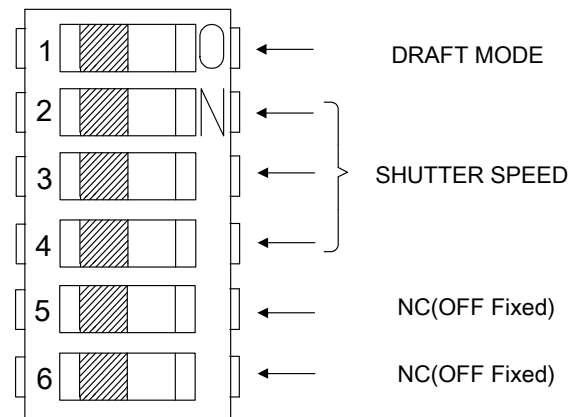

SW2 Inner-SW

### (1) Read out mode setting

Change internal Dip SW1(Factory setting: OFF)

OFF: 15Hz All Pixel Data Readout Mode (Normal mode)

ON: 60Hz High-Speed draft mode (As vertical 2 lines in 8 lines read out at the same timing under this mode, vertical resolution is reduced to 1/4)



(2) Shutter Speed setting

Internal DIP switch from 2 to 4)

Shutter speed is 1/15s fixed when Shutter mode is normal shutter.

SW2-2	SW2-3	SW2-4	Shutter speed
OFF	OFF	OFF	1/30
ON	OFF	OFF	1/60
OFF	ON	OFF	1/125
ON	ON	OFF	1/250
OFF	OFF	ON	1/1000
ON	OFF	ON	1/2000
OFF	ON	ON	1/4000
ON	ON	ON	1/10000

(3) External sync setting(HD/VD)

(a)SW 1

Function (indication)	Switch selection	Function selection
External sync connector selection (DATA ⇔ DCIN)	DATA	DATA OUT CONNECTOR
	DCIN	DC IN/SYNC CONNECTOR

(b)SW2

Function (indication)	Switch selection	Function selection
External sync input/output selection (IN ⇔ OUT)	IN	Input
	OUT	Output

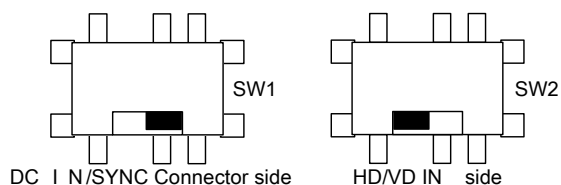
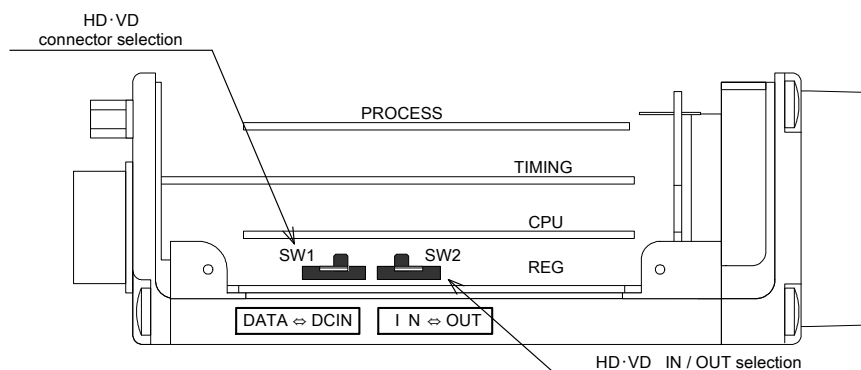

#### (4) RTS (Random Trigger Shutter) Pulse Control

The camera goes into RTS (Random Trigger Shutter) mode when TRIG terminal voltage is in HIGH (More than 1V), and starts light-exposure at the falling edge timing. Under FIX mode, the exposure-time is controlled with inner DIP switch settings. Under PULSE mode, the exposure-time is determined by pulse length. The exposure-time control is done in 1H steps. Be sure to set the pulse length longer than 1H (=Approximately 62.5 micro s). After video-output, it goes back into normal operation (= inner DIP switches) if the TRIG terminal voltage stays in LOW.

The exposure starts at the next HD timing immediately after TRIG IN.

#### Video output timing

##### -1 Fix mode

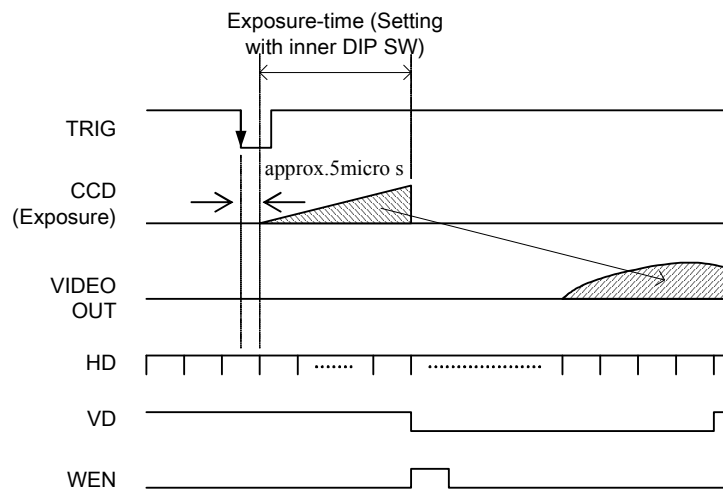

\*The VD is output in sync with the next HD after light-exposure

##### -2. Pulse mode

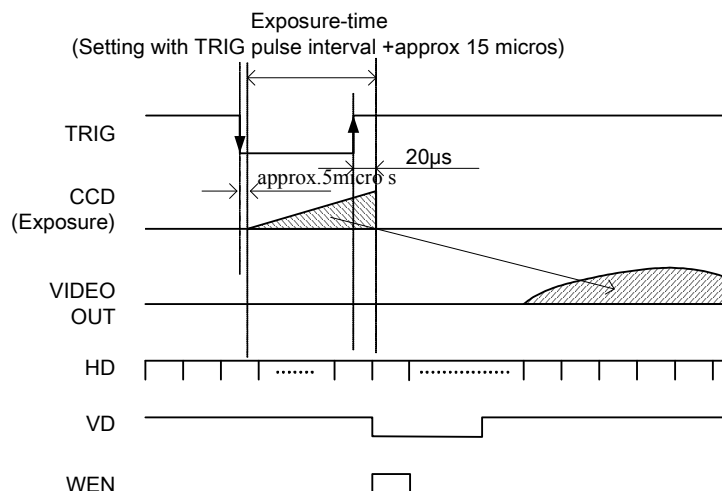

\*The VD is output in sync with the next HD after light-exposure

### (5) Multiple-shutter Mode Setting

Exposure is done during the one frame period which comes immediately after TRIG IN. Images are output at the readout signal (E.VD) timing. If the exposure is made more than one time before the readout signal input, superposed images are output. After video-output, it goes back into the normal operation (= shutter OFF) if the TRIG terminal voltage stays in LOW for 2V or longer consecutively, regardless of which RTS mode is currently set in.

#### -1 Fix mode

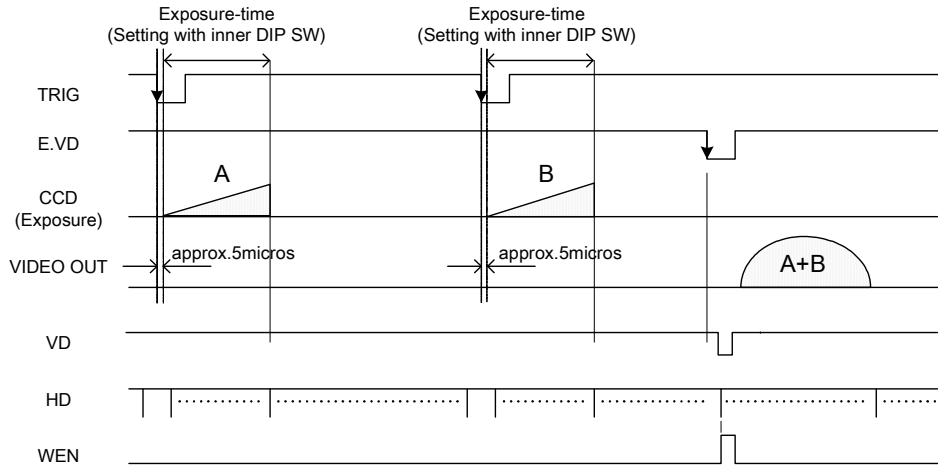

#### -1 Pulse mode

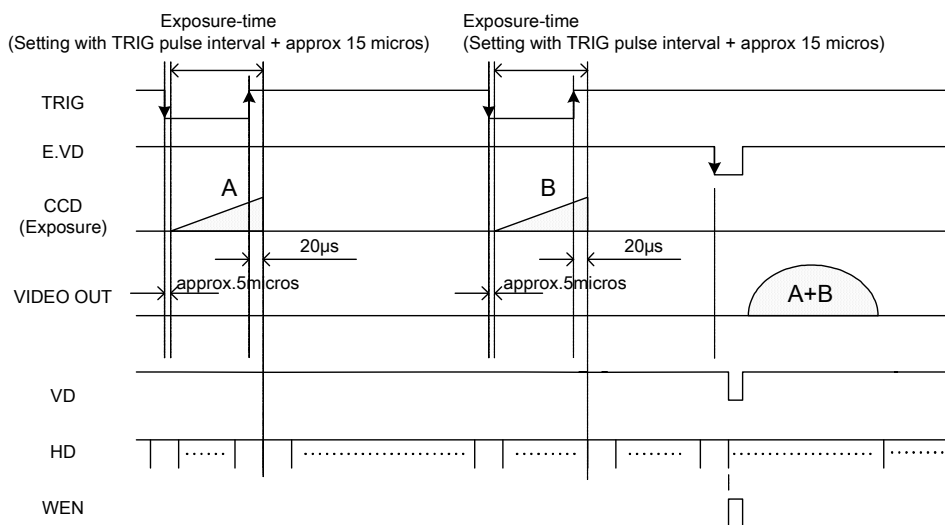

(6) Partial-scan Mode Setting

The partial-scan ON/OFF selection is made via the rear SW1 DIP5 (Initial factory setting: OFF)

OFF: Normal mode

ON: 1/2 --- Screen-center 1/2 readout

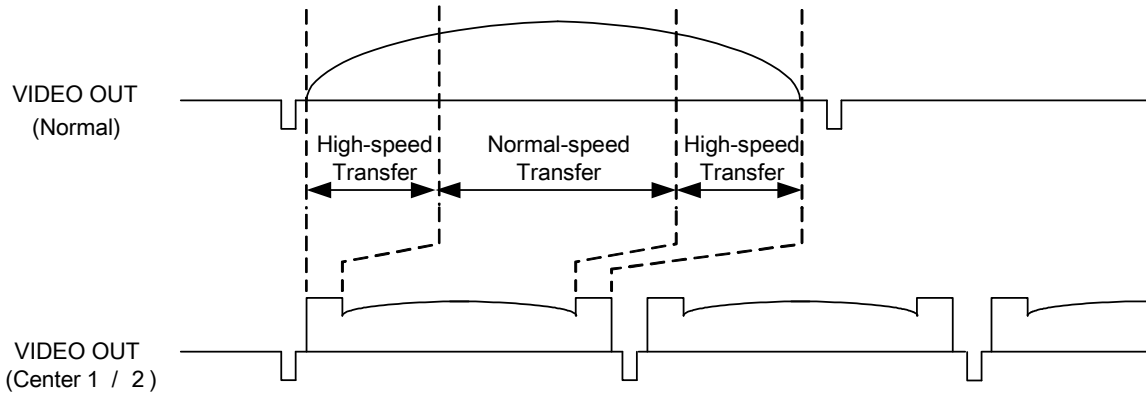

Screen half-center read out

- ⊙ Total line 1 0 4 6 line
- ⊙ Scan Range 5 2 3 line

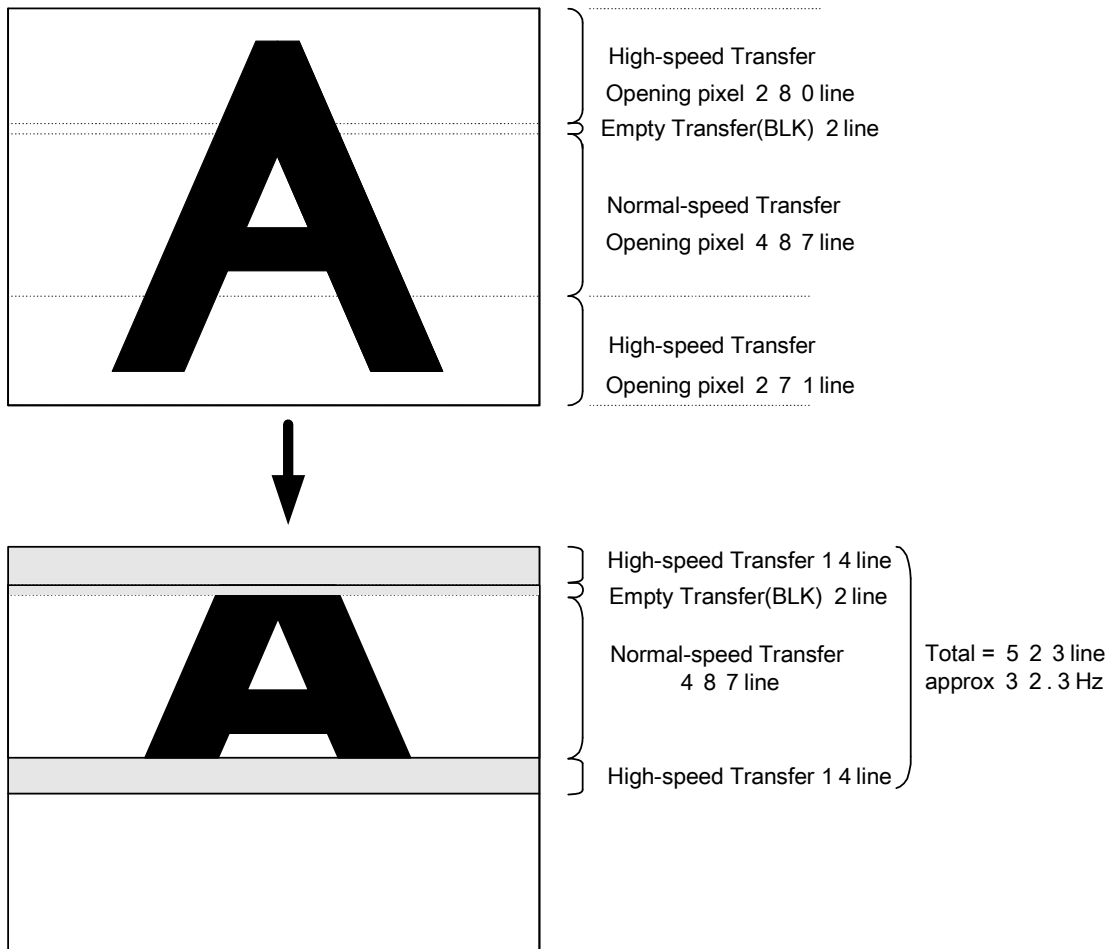

## 5. SPECIFICATIONS

Model	CS3910BH
[Electric specification]	
Image sensor	Interline CCD
Total pixel	1434(H) x 1050(V)
Active pixel	1392(H) x 1040(V)
Unit cell size	6.45(H) x 6.45(V) micrometer m
Optical size	Equivalent to 2/3 inch image pickup tube
Scanning system	Non-interlace
Aspect ratio	4:3
Sync system	Internal / External automatic switchover
Illumination	200 lx (F8 3200K)
Gamma correction	Gamma = 1.0(Fixed)
Video output	Digital output: EIA-644 Data: 10bit (28.63636MHz)
Scanning frequency	15.29Hz (All pixel data read-out mode) or 60.37Hz (High-speed draft mode)
AGC	+/- 6dB
Power source	DC12V +/- 10 percent
Power consumption	Approximately 2.7W
S/N	50dB(p-p/rms) (Under normal mode)
[Electric shutter specification]	
Shutter speed	8 scales from 1/30s through 1/10000s
RTS	Random Trigger Shutter ON/OFF selectable (factory setting: OFF) Fix mode --- Exposure-time determined by E shutter-speed Pulse mode --- Exposure-time determined by pulse width
Partial scan	ON/OFF selectable (factory setting: OFF) ON --- Screen center 1/2 readout
Multiple shutter	ON/OFF selectable (factory setting: OFF) Fix mode --- Exposure-time determined by E shutter-speed Pulse mode --- Exposure-time determined by pulse width
[Internal sync, signal specification]	
H drive frequency	28.63636MHz+/-100ppm
Scanning frequency	H: 15.998kHz+/-100ppm V: 15.29Hz+/-100ppm (All pixel data read-out mode) 60.37Hz+/-100ppm (High speed draft read-out mode)
[External sync, signal specification]	
External sync signal	
HD	TTL level, Negative, Input impedance: 10k-ohm Repeating frequency 15.998kHz +/- 1 % Pulse width: Longer than 5 micro s
VD	TTL level, Negative, Input impedance: 10k-ohm Repeating frequency 14.98Hz +/- 1 percent Pulse width: Over 1H(62.5 micro s)

Trigger signal    TTL level, Negative  
                           Input impedance: 10k-ohm  
                           Pulse width: Over 1H(62.5 micro s)

Multiple-shutter readout signal  
                           TTL level, Negative  
                           Input impedance: 10k-ohm  
                           Pulse width: From 62.5 micro s through 10ms

[Sync output signal specification]

Output signal

WEN    4V(p-p), Positive, Pulse width: 1H (62.5 micro s)

HD      [Output from DATA OUT]  
                   EIA RS644 (LVDS)  
                   Driver output voltage: +/- 350mV  
                   (Differential output) / 100-ohm

VD      [Output from DATA OUT]  
                   EIA RS644 (LVDS)  
                   Driver output voltage: +/- 350mV  
                   (Differential output) / 100-ohm

CLOCK [Output from DATA OUT]  
                   EIA RS644 (LVDS)  
                   Driver output voltage: +/- 350mV  
                   (Differential output) / 100-ohm

[Mechanical dimensions]

(1) Lens mount	C mount
(2) External dimension	49(W) x 35(H) x 98(D)mm
(3) Weight	Approx. 170g
(4) Chassis GND/ Isolation	Conduct from circuit GND and Chassis

**\* Combination of C-mount lens**

**As for the C-mount lens used combining this camera, the projection distance from bottom of the screw should use 9.9mm or less.**

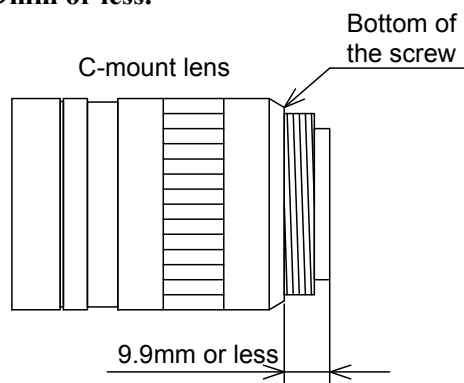

[Ambient condition]

Performance guaranteed  
                   Temperature : From 0 through 40 degree Celsius  
                   Humidity : From 10 through 90 percent (No condensing)

Operation guaranteed  
                   Temperature : From -5 through 45 degree Celsius  
                   Humidity : Less than 90 % (No condensing)

[Spectrum response characteristics (Typical)]

Refer to table SRC below. Graph reflects lens characteristics, but do not reflect that of light-source.

Table: Typical SRC

X-axis: Wave-length

Y-axis: Relative response

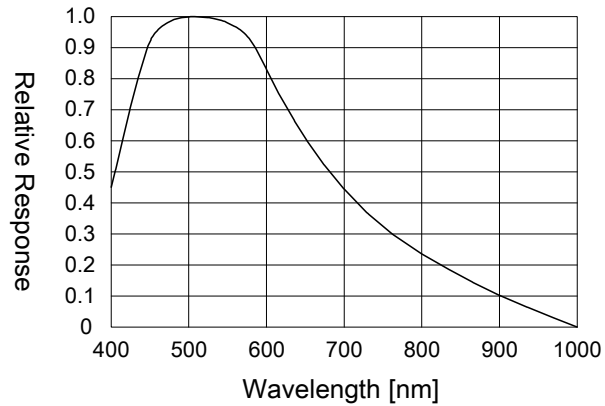

[Connector pin arrangement]

DC IN/SYNC

Connector (Camera side): HR10A-10R-12PB (Manufactured by HIROSE DENKI)

Plug (Cable side): HR10A-10P-12S (Manufactured by HIROSE DENKI)

Pin number	Signal name
1	GND
2	+12V
3	N.C
4	N.C
5	HD GND
6	E.HD IN
7	E.VD IN
8	GND
9	N.C.
10	WEN
11	TRIG
12	VD GND

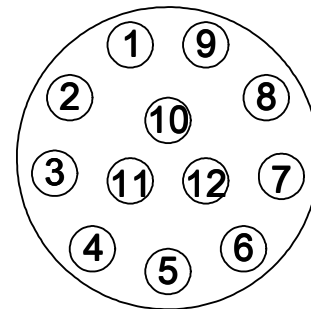

Rear-view

(2) DATA OUT

Connector (Camera side): DX10A-36S

Connector (Cable side): DX30A-36P, DX-36-CV1 (Cover)

Pin.	Signal name	Pin.	Signal name	Pin.	Signal name	Pin.	Signal name
1	DATA0-H	10	DATA4-L	19	DATA9-H	28	E.HD IN
2	DATA0-L	11	DATA5-H	20	DATA9-L	29	E.VD IN
3	DATA1-H	12	DATA5-L	21	VD OUT-H	30	N.C.
4	DATA1-L	13	DATA6-H	22	VD OUT-L	31	BUSY
5	DATA2-H	14	DATA6-L	23	HD OUT-H	32	WEN
6	DATA2-L	15	DATA7-H	24	HD OUT-L	33	N.C.
7	DATA3-H	16	DATA7-L	25	CLK-H	34	N.C.
8	DATA3-L	17	DATA8-H	26	CLK-L	35	GND
9	DATA4-H	18	DATA8-L	27	TRIG IN	36	GND

DATA0: LSB, DATA9: MSB

## 6. TIMING CHART

### 6-1. Digital output

EIA RS644 standard (LVDS)

Driver output voltage Plus/minus 350mV (Differential output) / 100-ohm

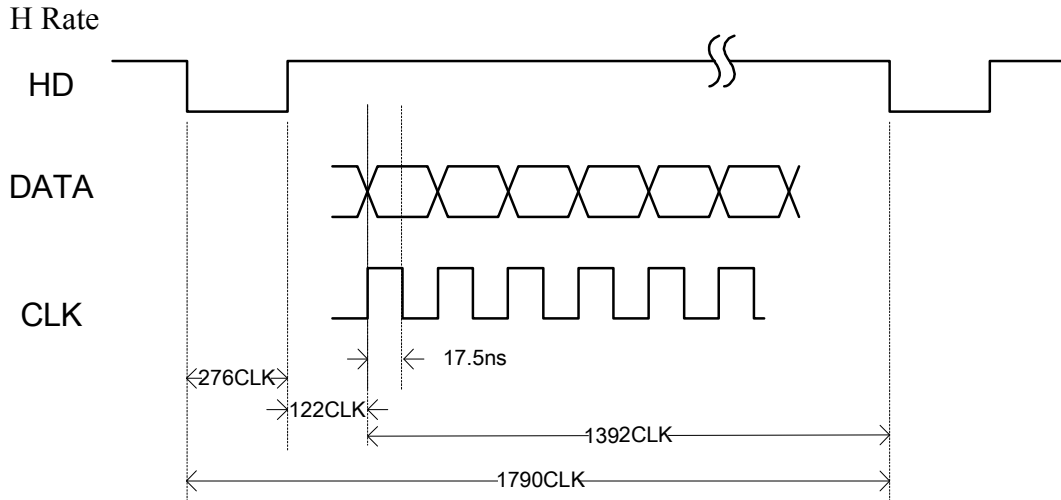

Total clock counts: 1790CLK / 1H  
 DATA counts: 1392CLK / 1H  
 CLK 34.92ns  
 V rate phase: Same as one in analog timing-chart

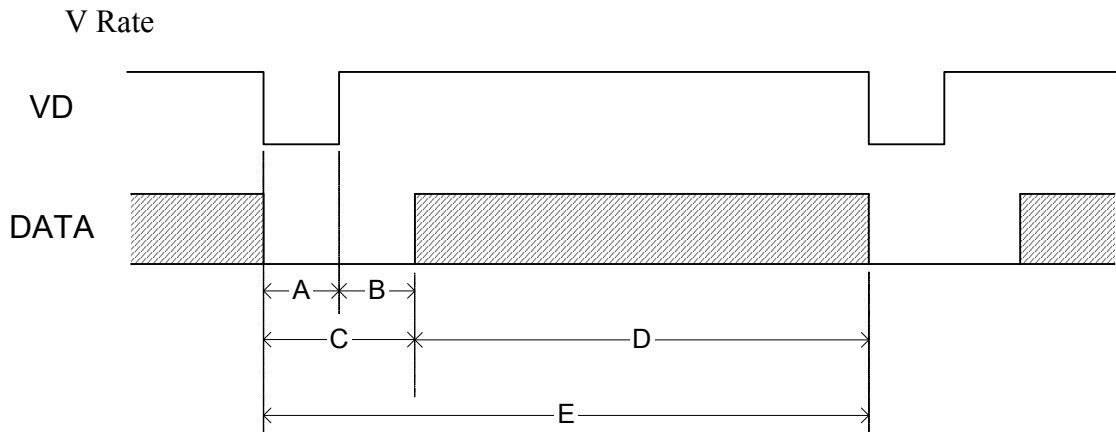

A=3H  
 B=3H  
 C=6H  
 D=1040H  
 E=1046H



### 6-2. External sync.

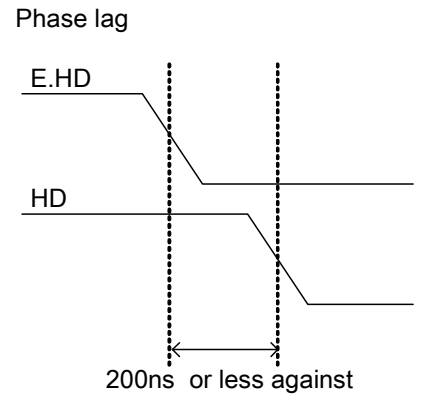
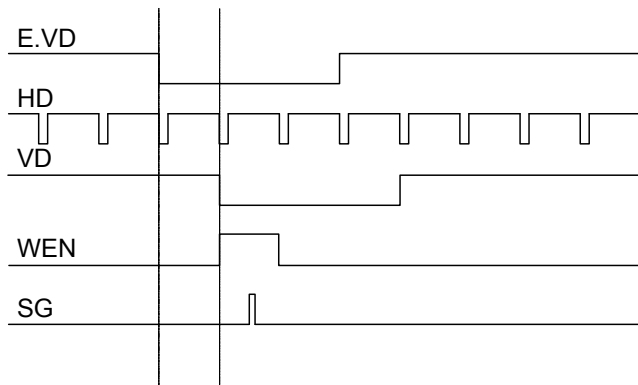

VD:  $1/15\text{Hz} = 65.4\text{ms}$  (1046H) Pulse width: Longer than 1H

### 6-3. Read out mode

\*15Hz All pixels read out

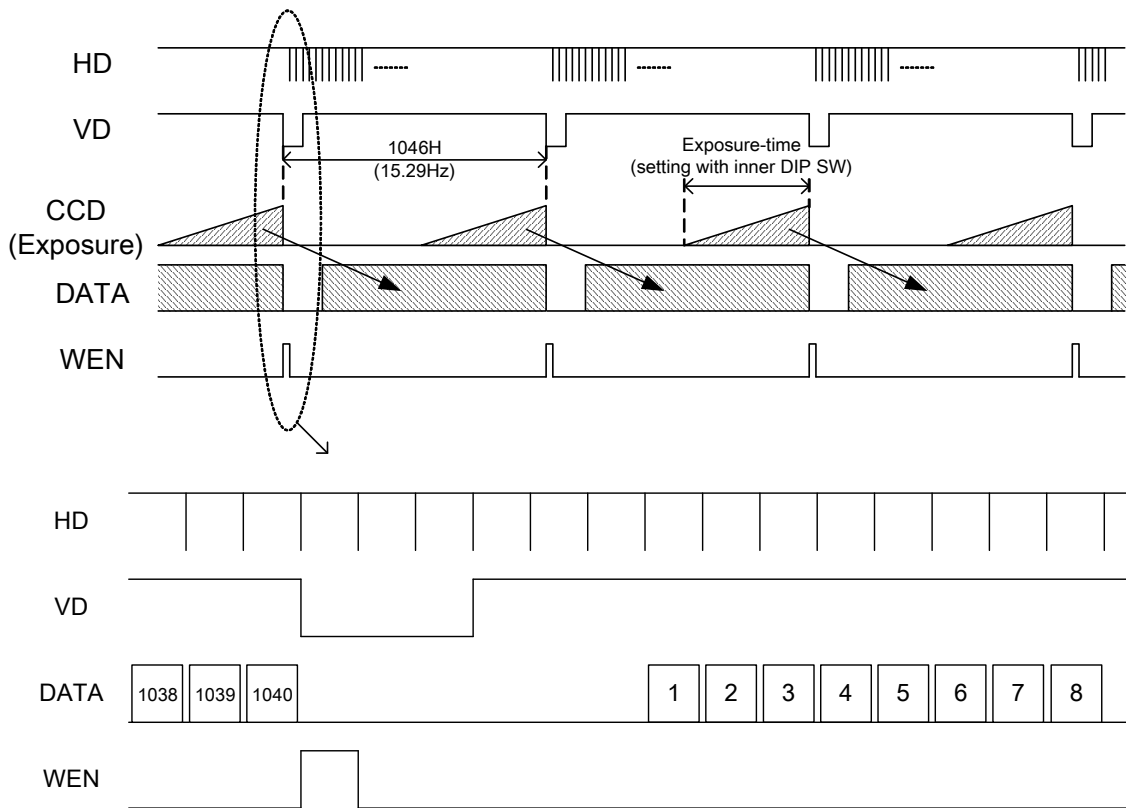



# 7. EXTERNAL-VIEW DRAWING

